

hl 2/5/5

The Scanhugger HL 2/5/5 is a small vertical shredder, capable of shredding all types of woodwaste (solid wood, particleboard, MDF, cardboard, paper) depending on the material to be processed and the desired chip quality, the machine can be mounted with different screen sizes.

Scanhugger HL 2/5/5 er den mindste træknuser i HL-serien, den er velegnet til knusning af alle typer træaffald (massivt træ, spånplade, MDF, pap, papir). Afhængig af materialetype og ønsket flisstørrelse kan maskinen monteres med forskellige soldperforeringer til henholdsvis fine/grove flistyper.

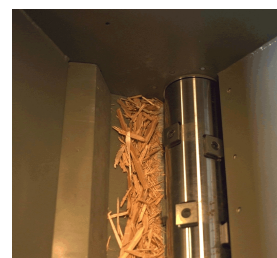

Rotor/knife
Rotor/kniv



screen
sold

Technical data / Tekniske data.

Hopper dimension / Magasinmål		524 x 612 mm
Hopper volume / Magasinindhold		0,3 cbm
Rotor diameter / Rotor diameter		Ø 140 mm
No. of knives / Knivantal	*	14
No. of counterknives / Antal modstål		1
Rotor speed / Rotoromdrejninger	**	90 ⁻¹
Main motor / Hovedmotor	**	7,5 kW
Screen perforation / Soldperforering	**	15 - 30 mm
Chip length / Flislængde	**	15 - 30 mm
Capacity / Kapacitet	**	80-130kg/60min
Weight / Vægt		450 kg
Sound level / Lydtrykniveau L _{pa}	***	81 dB

* Depending on rotor and type of knife

** Depending on motor size, material and screen perforation

*** In accordance with ISO/DIS 11204, prEN 691

Technical alterations reserved / Ret til tekniske ændringer forbeholdes

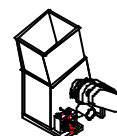

HL 2 SERIE

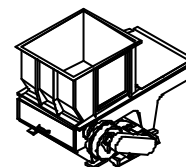

HL 3 SERIE

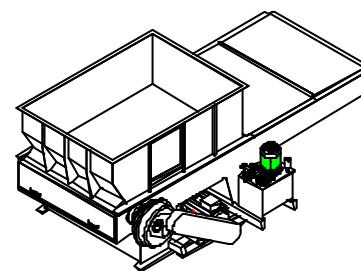

HL 4 SERIE

Scanhugger a/s

Herningvej 144 - 6950 Ringkøbing
Tel. +45 9734 3111 Fax. +45 9734 3175
www.scanhugger.com

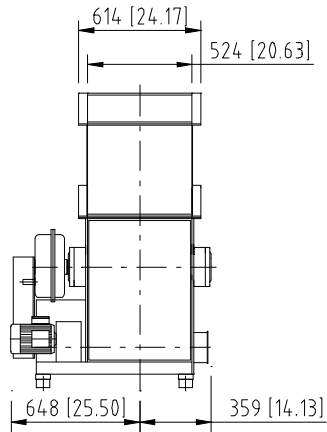

SIDE INDFØRING

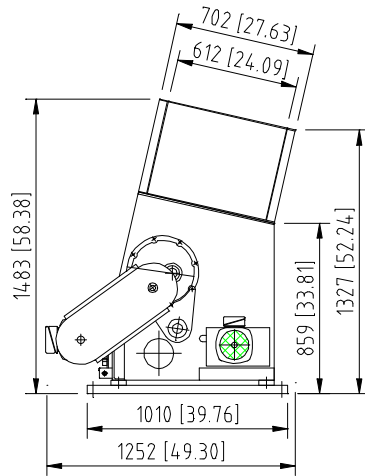

SIDE VENSTRE

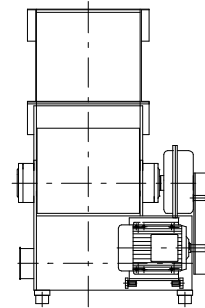

SIDE BAG

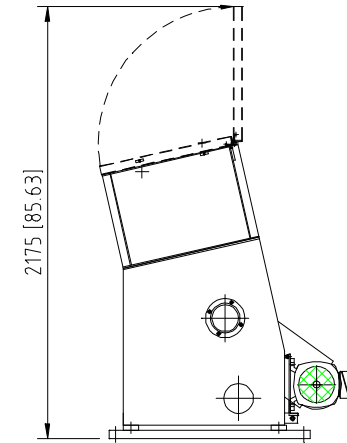

SIDE HØJRE

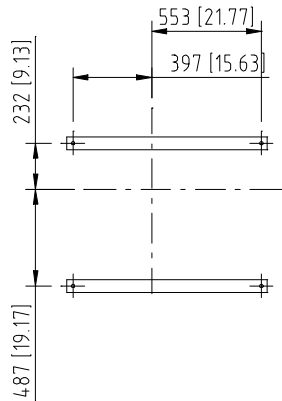

FODMÅL

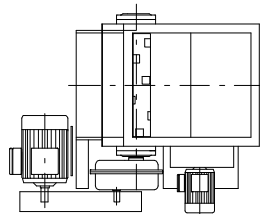

PLAN

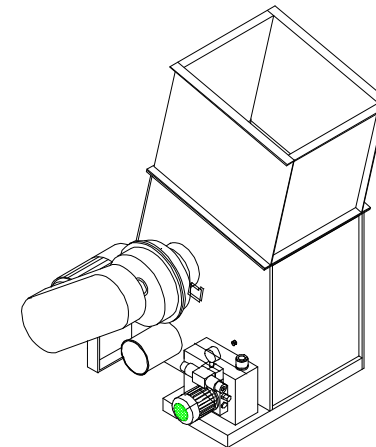

SCANHUGGER HL 2/5/5 MONTERET MED STANDARD TRAGT
 TRANSMISSION MONTERET I VENSTRE SIDE
 ALLE MÅL I MM [TOMMER]
 MASKINFOD MONTERET MED VIBRATIONS DÆMPERE
 TILSLUTNING TIL UDSUGNING I HØJRE/VENSTRE SIDE
 INTERNE FORBINDELSER TIL STYRE/KONTROL FUNKTIONER
 FØRT TIL SAMLEKASSE PÅ MASKINSIDE
 STYRESKAB TIL VÆGMONTERING

HOVEDMOTOR:
 HYDRAULIKANLÆG:
 SUGESTUDES:

RET TIL TEKNISKE ÆNDRINGER FORBEHOLDES

Pos.nr	Mgd	Benævnelse	Dimension	Bemærkning	
Konst	Sign	Format	Skala	Erstatter	Erstatter af
Titel				Fit	Dato
 HEDETRÆ A/S DK 6950 RINGKØBING TLF 9734 3111 FAX 9734 3175			Tegn.nr		
			denne tegning må ikke kopieres eller på nogen anden måde gøres tilgængelig for tredjepart this drawing is not to be copied, printed or to be available to any unauthorized person without our specific permission		